



AcadeMir Charter Schools

**2024 SUMMER
INCOMING 8TH GRADE
MATH PACKET**



AcadeMir Charter School West 2024 Summer Learning Requirements

Dear Parent(s)/Guardian(s),

In preparation for the 2024 – 2025 school year and to ensure that our students maintain growth-oriented academia during the summer, the school curriculum team has created the following Summer Learning assignment for each student to complete by the first day of school. Each student must complete the Summer Learning Packet over the summer and turn it in to your classroom teacher by August 23, 2024.

Summer Reading

ACSW students will be expected to read the novel from the reading list for their incoming grade level. For example, if your child is entering 1st grade in the fall, he/she would read the 1st grade novel and complete the activity. Please note that this assignment will be worth one grade for Reading and one grade for Language Arts.

Mathematics Activities

ACSW students are required to complete the mathematics packet that pertains to their incoming grade level and/or assignment. For example, if your child is in the Accelerated Mathematics course in the elementary level, he/she needs to complete the Accelerated packet. For middle school, Algebra, Geometry, etc. is separated from the ELA, Science, and Social Studies packet. Please ensure that you do all the components.

Thank you for your partnership in ensuring your child continues to strive for excellence over the summer!
We look forward to an outstanding 2024 – 2025 school year!

Sincerely,

Susie Bello, Principal
AcadeMir Charter School West
bello@academircharterschoolwest.com

ACADEMIR CHARTER SCHOOLS



Dear incoming 8th grader,

We hope you had a wonderful 7th grade year!

This summer packet has been created to help you review and prepare for 8th grade Mathematics. It covers many of the math topics that you learned in class this year which we will be building on next year.

- Please show all your work for every problem in the packet. You can show your work on a separate sheet of paper.
- The paper should be neatly organized- with every problem numbered.
- Highlight, draw a box, or draw a circle around your final answers.
- Calculators may be used to help you complete this section of your summer packet since they will be used during the school year.

*Note: If you submit your summer packet without work, you **WILL NOT** receive full credit.

The completed packet is due on the first week of school by:
Friday, August 23rd, 2024.

This packet will count as your first math grade of the new school year.

We hope you have a nice summer break and look forward to seeing you in August.

13. The cost of 2 pounds of coffee is \$17.95. To the nearest dollar, what is the cost of 5 pounds of coffee?

- A \$34 C \$45
 B \$36 D \$90

14. On a map, the distance between two cities is 5.25 inches. The map scale is 1 in.:25 mi To the nearest mile, what is the actual distance between the two cities?

- A 13 mi C 125 mi
 B 30 mi D 131 mi

15. Patti got a new part-time job. Her hourly wage increased from \$10.50 to \$12.39. What was the percent increase in Patti's hourly wage?

- A 1.8% C 18%
 B 15.25% D 189%

16. To the nearest cubic centimeter, what is the volume of the prism below?

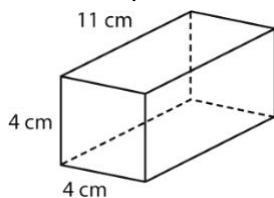

- A 19 cm^3 C 88 cm^3
 B 44 cm^3 D 176 cm^3

17. A bag contains 12 blue marbles, 5 red marbles, and 3 green marbles. Jonas selects a marble and then returns it to the bag before selecting a marble again. If Jonas selects a blue marble 4 out of 20 times, what is the experimental probability that the next marble he selects will be blue?

- A .02% C 20%
 B 2% D 200%

18. The circumference of a circle is 36π inches. What is the radius of this circle?

- A 9 in. C 18 in.
 B 12 in. D 36 in.

19. Which equation is represented by the graph below?

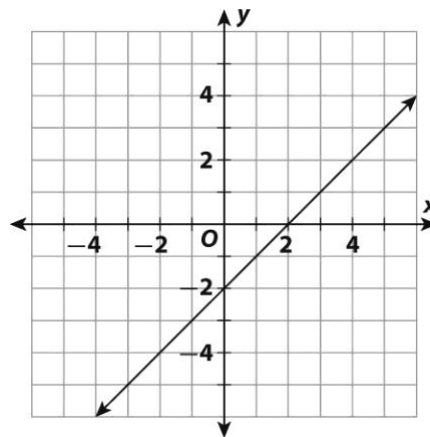

- A $y + 2 = x$
 B $y + 1 = x$
 C $y - 1 = x$
 D $y - 2 = x$

20. To the nearest square inch, what is the surface area of the square pyramid below

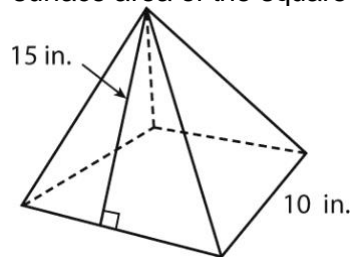

- A 175 in^2 C 400 in^2
 B 200 in^2 D 700 in^2

21. Cybil flips a coin and rolls a fair number cube at the same time. What is the probability that she will toss tails and roll a number less than 3?

- A $\frac{1}{6}$ C $\frac{2}{5}$
 B $\frac{1}{3}$ D $\frac{1}{2}$

22. The Rogers family drove 220 miles in 5.5 hours. How many miles would they drive at this same rate in 4 hours?

- A 88 mi C 160 mi
 B 147 mi D 176 mi

23. Your school is choosing a new school mascot to represent all team sports. Which group should you ask to get a random sample of student opinion?
- A students on the basketball team
 - B every 10th student that enters the cafeteria
 - C the first 20 seniors at the library
 - D students on the cheerleading squad
24. A rectangle is 14 inches long and 4 inches wide. A smaller, similar rectangle is 2 inches wide. To the nearest inch, what is the length of the smaller rectangle?
- A $3\frac{1}{2}$ in.
 - B 7 in.
 - C 8 in.
 - D 28 in.
25. There are 30 colored marbles inside a bag. Six marbles are yellow, 9 are red, 7 are white, and 8 are blue. One is drawn at random. Which color is most likely to be chosen?
- A white
 - B red
 - C blue
 - D yellow
26. Which table represents the same linear relationship as the equation $y = 2x + 6$?

A

x	0	1	2	5
y	6	7	8	10

B

x	2	3	4	5
y	8	9	10	11

C

x	2	3	4	5
y	10	12	14	16

D

x	2	3	4	5
y	16	18	20	22

27. Evan's dog weighs $15\frac{3}{8}$ pounds. What is this weight written as a decimal?
- A 15.125 lb
 - B 15.375 lb
 - C 15.385 lb
 - D 15.625 lb
28. The spinner below is divided into sections that are red, green, or blue. What is the probability that the spinner will land on red or green?

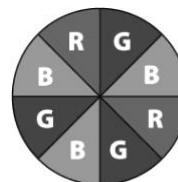

- A $\frac{1}{4}$
 - B $\frac{3}{8}$
 - C $\frac{1}{2}$
 - D $\frac{5}{8}$
29. Based on the dot plots below, which of the following is a true statement?

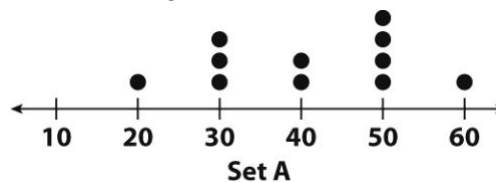

- A Set B has the greater mode.
 - B Set A has more items than set B.
 - C Set A is more symmetric than set B.
 - D Set B has the greater range.
30. For a trip, Eli packed 3 shirts, 3 pairs of pants, and 2 pairs of shoes. How many different outfits can Eli make?
- A 6 outfits
 - B 8 outfits
 - C 9 outfits
 - D 18 outfits

31. The net of a triangular prism is shown below. What is the surface area of the prism?

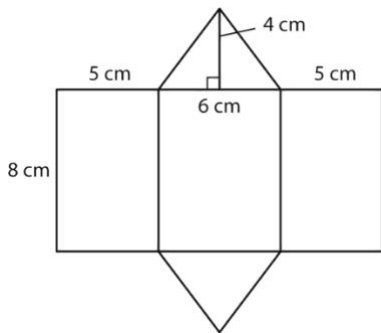

- A 128 cm^2 C 176 cm^2
 B 152 cm^2 D 304 cm^2
32. A middle school has 470 students. Regina surveys a random sample of 40 students and finds that 28 have cell phones. How many students at the school are likely to have cell phones?
- A 132 students C 329 students
 B 188 students D 338 students
33. Which of the following is the solution to the inequality below?
- $$-5x - 10 < 20$$
- A $x > -6$ C $x < -6$
 B $x > -2$ D $x < -2$
34. Nina operates a dog walking service. She charges a flat fee of \$15 plus \$5 per hour. Which equation represents this linear relationship?
- A $y = 15x - 5$ C $y = 5x - 15$
 B $y = 15x + 3$ D $y = 5x + 15$

35. To the nearest tenth, what is the area of the figure below? Segment BF is a line of symmetry of the pentagon $ABCDE$. Use 3.14 for π .

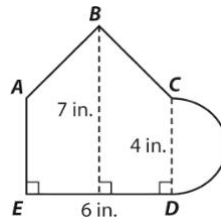

- A 30.3 in^2 C 39.3 in^2
 B 33.0 in^2 D 48.3 in^2
36. What is the measure of $\angle BGD$?
-
- A 40° C 90°
 B 50° D 130°
37. The Masim family's monthly budget is shown in the circle graph below. The family has a current monthly income of \$5,000. How much money do they spend on food each month?

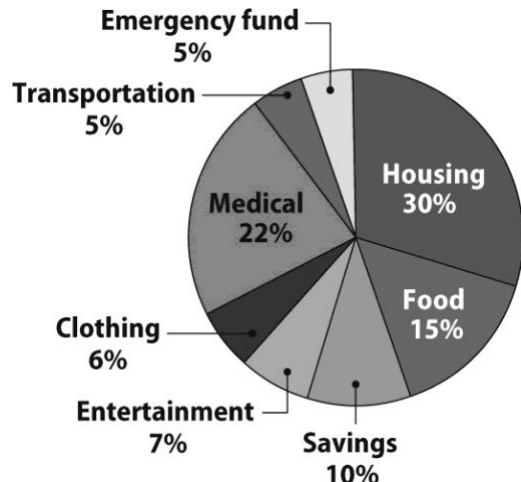

- A \$250 C \$750
 B \$500 D \$1,100

38. A box is 30 inches long, 16 inches wide, and 14 inches high. To the nearest cubic inch, what is the volume of the box?
- A 224 in^3 C 480 in^3
 B 420 in^3 D $6,720 \text{ in}^3$
39. A circle has a radius of 7 inches. What is the area of the circle?
- A 21.98 in^2 C 153.86 in^2
 B 43.96 in^2 D 615.44 in^2
40. The circle graph shows the results of an employment survey of 800 people. How many of the people surveyed were unemployed?

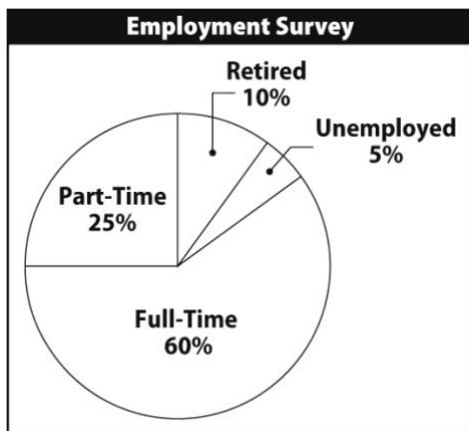

- A 20 people C 80 people
 B 40 people D 120 people
41. An equestrian center is surveying riders to determine which type of horse is preferred. Which of the following is a random sampling method?
- A The equestrian center manager surveys the first 50 riders.
 B The equestrian center surveys every tenth rider at the stable.
 C The equestrian center manager surveys 50 of his friends.
 D The equestrian center surveys the 50 best riders.

42. A 16-inch piece of string is 40.64 centimeters long. To the nearest 0.01 a centimeter, how long will a 42-inch piece of ribbon be?
- A 56.64 cm
 B 82.64 cm
 C 106.68 cm
 D 1,706.88 cm
43. One circle has a diameter of 6 inches. A second, larger circle has a diameter that is four times the diameter of the first circle. What is the ratio of the area of the smaller circle to the larger circle?
- A 2:3 C 1:16
 B 1:6.4 D 1:64

Use the box plot for 44–45.

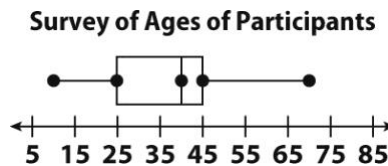

44. What is the median?
- A 10 C 40
 B 25 D 45
45. What is the interquartile range?
- A 10 C 40
 B 20 D 45

Use the figure for 46–47.

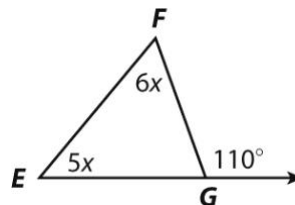

46. What is the measure of $\angle FEG$?
- A 30° C 50°
 B 40° D 70°

47. Which of the following is **not** true?

- A $5x + 6x = 70^\circ$
- B $5x + 6x < 180^\circ$
- C $5x + 6x = 110^\circ$
- D $5x + 6x + 70^\circ = 180^\circ$

48. Which equation represents the data shown in the table below?

Cost (y)	5	9	13	17
Gallon (x)	2	4	6	8

- A $y = 2x + 1$
- B $y = 3x - 1$
- C $y = 2.5x$
- D $y = 2.5x + 1$

49. Which number line represents the solution to the inequality below?

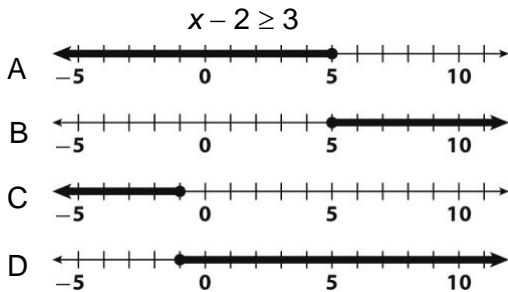

50. Three stores have the same tablet computer on sale. The regular price of the tablet is \$150. Store A is offering the tablet on sale at 15% off the regular price. Store B is offering a \$25 coupon to be deducted from the regular price. Store C is offering a rebate of \$20.00 to purchasers. Store D has the tablet on sale for \$120.00. Which store is offering the tablet at the lowest cost?

- A Store A
- B Store B
- C Store C
- D Store D

51. The circumference of a circle is 12π feet. What is the radius of the circle?

- A 3 ft
- B 6 ft
- C 12 ft
- D 24 ft

52. The Demir family has a monthly budget of \$5,500. Mrs. Demir works fulltime and takes home \$4,000 each month. Mr. Demir works part-time and brings home earnings \$16 per hour. How many hours per month must Mr. Demir work at his part-time job to make sure that he and Mrs. Demir have met their monthly budget?

- A 37.5 h
- B 75 h
- C 93.75 h
- D 125 h

53. Chana has a bag of colored tiles. Without looking, she removes one tile, records the color, and replaces it. She repeats this process 40 times and records the results in the table.

Color	Frequency
Red	9
Blue	12
Green	14
Yellow	5

What is the probability that Chana will not pick a yellow tile on her forty-first time?

- A $\frac{1}{8}$
- B $\frac{1}{4}$
- C $\frac{7}{8}$
- D $\frac{9}{10}$

54. Mills Middle School has 280 students. A random sample of 30 students were asked how many cars their families have at home. The results are shown in the dot plot below.

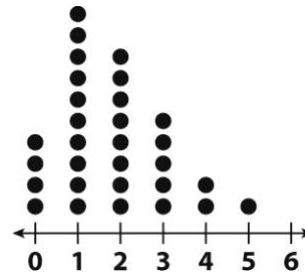

Which of the following is a qualitative statement that is reasonable based on the data?

- A The fewest number of cars at home is 0.
- B Most students have 2 or fewer cars at home.
- C Most students have 3 or more cars at home.
- D The median number of cars at home is 3.

55. Aaron buys 3 ties for \$19.95 each, a belt for \$23.50, and a pair of boots for \$124.95. The sales tax in his city is 5%. To the nearest cent, what is the total cost of Aaron's purchases?

- A \$176.82
- B \$197.77
- C \$218.72
- D \$304.29

56. The probability of spinning an odd number on a spinner is 62 percent. What is the probability of **not** spinning an odd number?

- A 0.28
- B 0.38
- C 0.48
- D 0.62

57. The dot plots below show the number of hours per week that some sixth graders and eighth graders play video games. What is the difference between the mode for sixth graders and the mode for eighth graders?

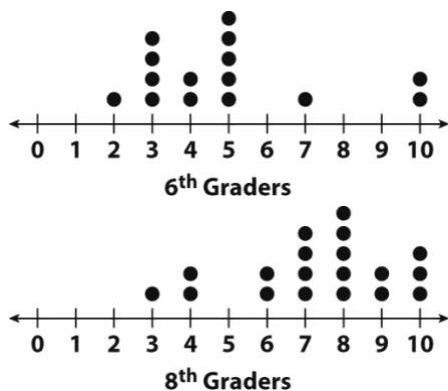

- A 3 h
- B 5 h
- C 8 h
- D 13 h

58. A baseball player gets a hit 20% of the times he is at bat. Out of the next 15 times at bat, how many hits can you expect the player to get?

- A 2 hits
- B 3 hits
- C 5 hits
- D 12 hits

59. What is the volume of the prism below?

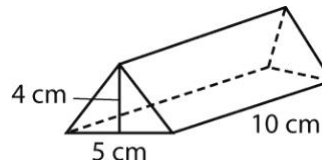

- A 100 cm³
- B 125 cm³
- C 150 cm³
- D 200 cm³

60. What is the value of x in the equation below?

$$5x - 35 = 40$$

- A -1
- B 1
- C -15
- D 15

61. To the nearest hundredth, what is the area of the figure below? Use 3.14 for π .

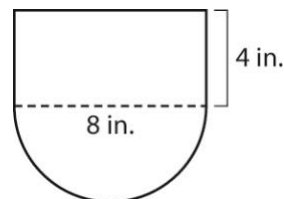

- A 57.12 in²
- B 128 in²
- C 200.96 in²
- D 328.96 in²

62. Mike has \$75 to spend at a local model car show. The entrance price for the show is \$20. At one seller's stand, Mike finds some model cars that he likes that are \$7.50 each. What is the maximum number of model cars that Mike can buy at that stand?

- A 6 cars
- B 7 cars
- C 8 cars
- D 10 cars

63. A 7-by-7 foot rug is shown below. A coin is tossed onto the rug randomly. What is the probability that the coin will land on an area that is white?

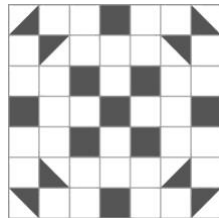

- A 26.53% C 73.47%
 B 36.11% D 276.92%
64. On a road map, the distance from Greenmount to Yorktowne is 2 inches. The map scale is 1 in.:25 mi. How many miles is the actual distance between the two cities?
- A 12.5 mi C 50 mi
 B 25 mi D 125 mi
65. The temperature in Jukkasjarvi, Sweden, was -3° at 3 P.M. After 6 hours, the temperature dropped to -15° . The temperature dropped the same amount each hour. What was the change in temperature each hour?
- A -2° C 3°
 B -5° D 12°
66. The two quadrilaterals below are similar. What is the length of \overline{EF} ?

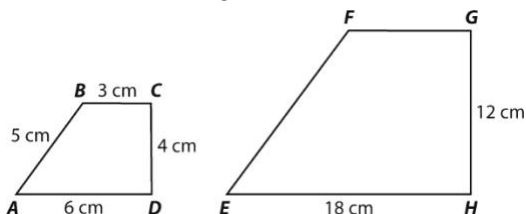

- A 9 cm C 17 cm
 B 15 cm D 22 cm
67. The Canadian \$2 coin has a diameter of 28 millimeters. To the nearest 0.01 mm, what is the circumference of this coin?
- A 87.92 mm C 615.44 mm
 B 175.84 mm D 2,461.76 mm

68. Rinaldo is buying a new truck for \$36,000. He is entitled to an 8% rebate. How much will the truck cost after the rebate?
- A \$22,800 C \$33,120
 B \$29,520 D \$35,999
69. A bike rental company charges a \$10 fee plus \$5 per hour. Sofia has \$25 to spend. Which inequality could you use to find x , the number of hours Sofia could rent a bike?
- A $10x + 5 > 25$ C $10x + 5 \geq 25$
 B $5x + 10 < 25$ D $5x + 10 \leq 25$
70. To the nearest square meter, what is the area of the figure below?

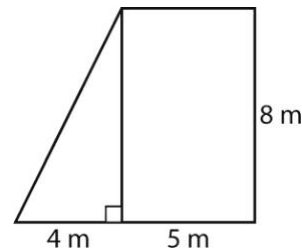

- A 32 m^2 C 56 m^2
 B 40 m^2 D 72 m^2
71. The Dead Sea is at an elevation of $-1,360$ feet. A seabird is flying over the Dead Sea at an elevation of -422 feet. If the bird lands on the Dead Sea, what will be its change in elevation?
- A $-1,782$ ft C 938 ft
 B -938 ft D 1,782 ft
72. On a scale drawing, the image of an alligator is 7 inches long. The scale factor is $\frac{1}{25}$. What is the actual length of the alligator in inches?
- A 28 in. C 175 in.
 B 35.7 in. D 280 in.